



Warmtepompen in de industrie

Jan Gerritsen

Innovation Manager GEA HRS

30 juni 2022

Ontstaan Post HBO Koudetechniek

- Start 1963 als Applicatiecursus:
 - Locatie HTS Den Bosch (zaterdagen)
 - Lesinhoud van de Technische Hogeschool Delft
 - Docenten van Grenco
 - Auspiciën van de NVvK

Opleidingsaanbod

Post HBO Koudetechniek:

- 1 jaar theorie: Product, Systeem en Componenten
- ½ jaar Afstudeer Project

Masterclasses

- CO₂ Transkritisch, Ede (4 dagen met practicum en software)
- Industriële Warmtepompen, Woerden (2 dagen)

Koppelcursus

- ½ jaar, Apeldoorn: vanaf MBO4 instromen naar Post HBO

Start nieuwe opleidingen

- Post HBO koudetechniek: **september 2023**
- Koppelcursus (MBO4): **januari 2023**
- Masterclasses WP + CO₂: **november 2022**
- Opgave: www.PostHboKoudetechniek.nl

GEA Truck

Een jaar lang toeren door heel Europa met als motto
“Rolling out innovations”



GEA Truck



Our applications

In touch with GEA every day

DAIRY FARMING
& PROCESSING

FOOD

BEVERAGES

PHARMA

CHEMICAL

HEATING &
REFRIGERATION

MARINE



Approx. one quarter of processed milk comes from GEA production systems

Every third chicken nugget is produced using GEA technology

Approx. every third process line for instant coffee was installed by GEA

Approx. every second liter of beer is brewed with the aid of systems and process solutions from GEA

Every fourth liter of human blood for making plasma-derived products is processed using GEA equipment

More than one third of all polymer producers are using GEA drying technology

Each industry we serve utilizes industrial refrigeration technology from GEA

Every second container ship in the world sails with GEA marine equipment on board

GEA IS THE ENGINE BEHIND ALL THIS... AND HAVE A MORAL RESPONSIBILITY TO DE-CARBONIZE



©GEA - Cooling Matters



Masterclass Warmtepompen Industrie



Warmtepompen raken steeds meer ingeburgerd in de gebouwde omgeving. Echter de industrie is nog maar recentelijk met deze techniek begonnen. Aan de industriële warmtepompen worden andere eisen gesteld dan aan die in de woningbouw. Ook is de inpassing van warmtepompen complexer, veel meer gevarieerd qua bedrijfscondities, zoals de temperatuurrange van 50°C tot 150°C. De warmtebronnen zijn veel meer divers.

Er bestaan opleidingen in warmtepompen voor de gebouwde omgeving maar geen specifieke opleiding voor industriële warmtepompen die ingaat op de specifieke condities in de industrie. Om deze reden biedt de Stichting Post HBO Koudetechniek (SPHBOK) de opleiding "Warmtepompen voor de industrie" aan.

Warmtevraag industrie en T

Table 1-5: Estimates of industrial heat consumption per temperature range per industrial sectors

Heat demand 2018 (PJ)	Total heat demand	Steam from CHP	<100 °C	100-250 °C	250-500 °C	>500 °C
Food industry	61	12	30	30	0	0
Paper Industry	17	7	0	17	0	0
Chemical industry	247	44	12	28	66	141
Industrial gasses	7	0	0	0	0	7
Steam crackers industry	160	0	0	4	47	109
Ammonia and N-fertiliser	28	0	0	0	3	24
Wider chemical ind	33	0	12	24	16	1
Steel	31	2	0	1	7	23
Refineries	119	10	0	2	50	68

Bron RHDHV-PDC, 2020

De warmtetransitie

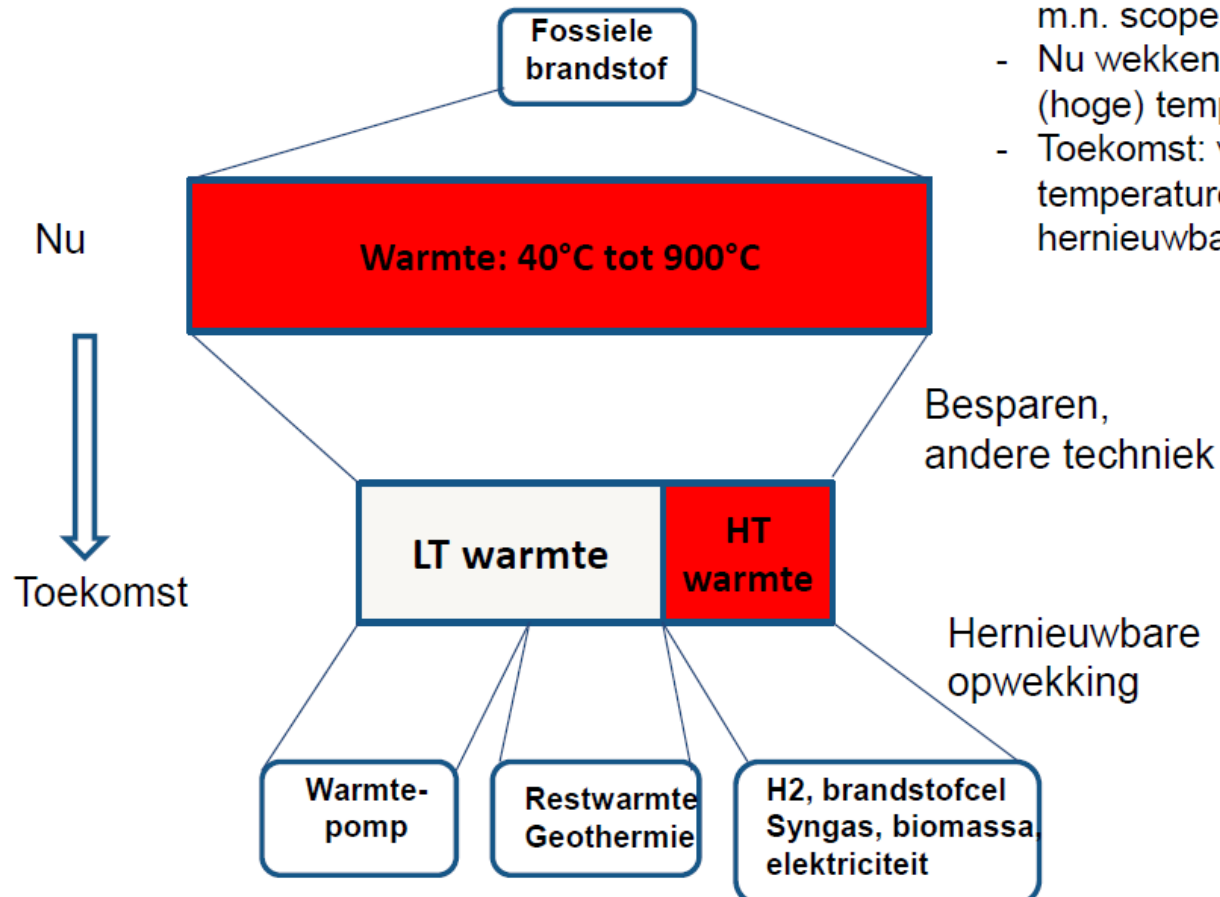

- Warmte is de grootste verbruiker en is m.n. scope 1
- Nu wekken we alle warmte op met één (hoge) temperatuur
- Toekomst: warmte op meerdere temperaturen rendabel, met hernieuwbare energie opwekken

Conventionele Energie-infrastructuur

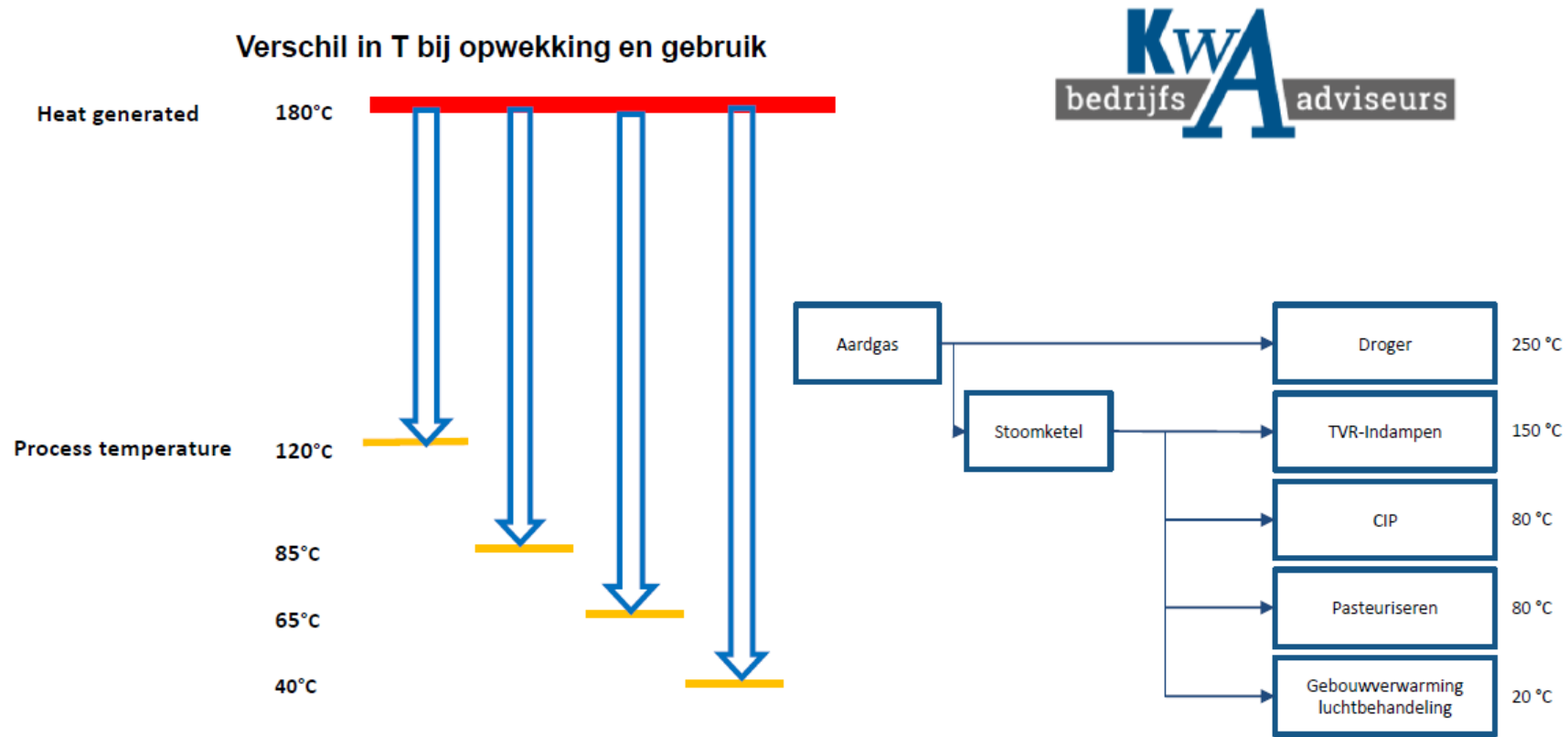

Heat pumps in industrial refrigeration

We all have one, its just called a refrigerator..

Heat pump: What is it?

They transport heat from a lower to a higher temperature level

All refrigeration systems are basically heat pumps.

Our refrigerator absorbs the heat from our food, boosts it in temperature and this heat (+the power) warms our kitchen/home.



Heat pumps allow us to use this heat to cook

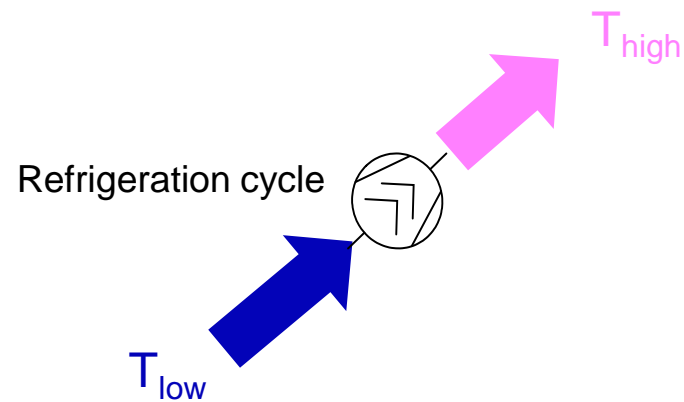

Warmtevraag sectoren en warmteaanbod uit condensators*, studie KWA/RVO 2016

Sectoren met koeling en energiegebruik	Warmte vraag	Elektriciteit finaal	Elektriciteit voor koeling	Condensator warmte 40° C
	PJ/j	PJ/j	PJ/j	PJ/j
V&G industrie	60	23	6	24
Industrie	496	116	13	56
Diensten, overheid en agrarisch	54	42	10	47

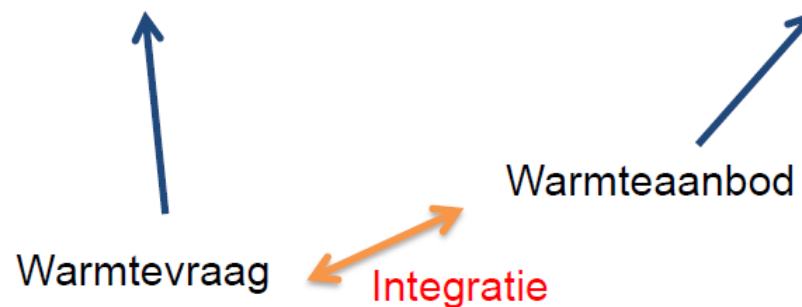

*Compressie koelmachines

Combineren

understanding our thermal needs!

Product Intake

Final Product

POULTRY



+38 °C

Defeathering



+52 °C

Chilling



+2 °C



+2 °C

DAIRY
BEVERAGE



+2 °C

Pasteurisation



+74 °C

Chilling



+2 °C



+2 °C

VEGETABLES



+20 °C

Blanching



+80 °C

Freezing



-18 °C



-22 °C

Heat pumps

understanding our thermal needs!

POULTRY

Product Intake



+38 °C

Defeathering



+52 °C

Chilling



+2 °C

Final Product



+2 °C

DAIRY BEVERAGE



+2 °C

Pasteurisation



+74 °C

Chilling



+2 °C



+2 °C

VEGETABLES



+20 °C

Blanching



+80 °C

Freezing



-18 °C



-22 °C

HEAT/ENERGY IN

HEAT/ENERGY OUT

..THE SAME HEAT,
just the wrong
temperature!

Heating Old and New

80% Efficient Boiler

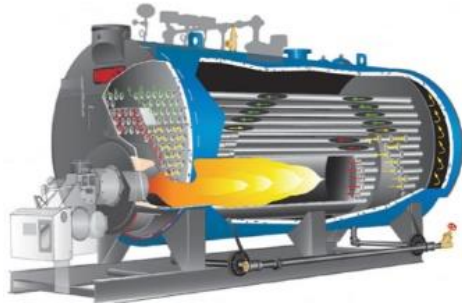

Heat capacity requirement = 1,000kw (1,594kg/hr, steam)

Temperature of process/water required = +76°C

Fuel Burned (NG) = 1,250kw

Cost per hour (0.02p/kwhr) = £25 (excl. carbon tax)

Carbon emissions (0.227kg/kw)= 283kgCO₂/hr

740% Efficient Heat pump (+35/76°C)

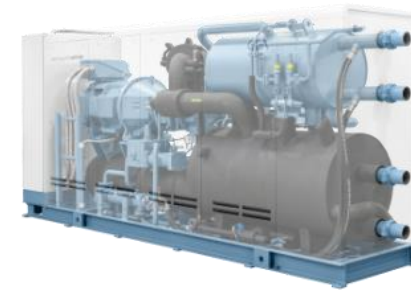

Heat capacity requirement = 1,000kw

Temperature of process/water required = +76°C

Power (Electrical) = 135kw

Cost per hour (0.1p/kwhr) = £13.5 (excl. carbon tax)

Carbon emissions (0.232kg/kw. 2020 UK grid)= 31kgCO₂/hr

Heating/Cooling in Dairy with Heat Pump

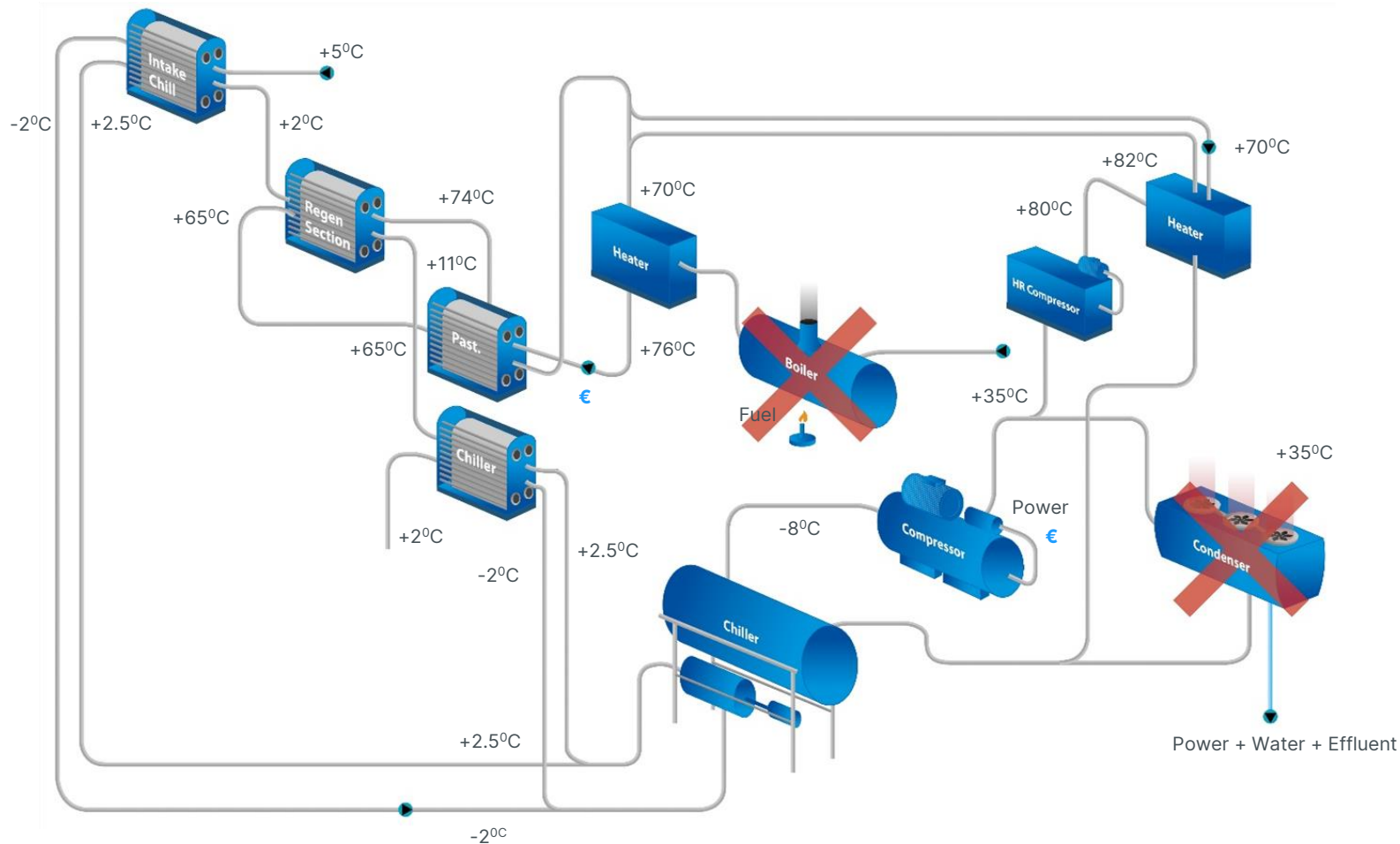

9.5 Million Itr/wk Fresh Milk

Heating Cost

6,440kwhr/wk (7 day/week): x 52 = 0.33 million kWh/year energy (electricity) used

Refrigeration Cost

14,280kwhr/wk (7day/week): x 52 = 0.74 million kWh energy (electricity) used

Water used

242m3/wk (7day/wk): x 52 = 12.5k m³/year

Total energy = 1.07 million kWh/year

Emissions = 321 tons CO₂e



Schillenmodel

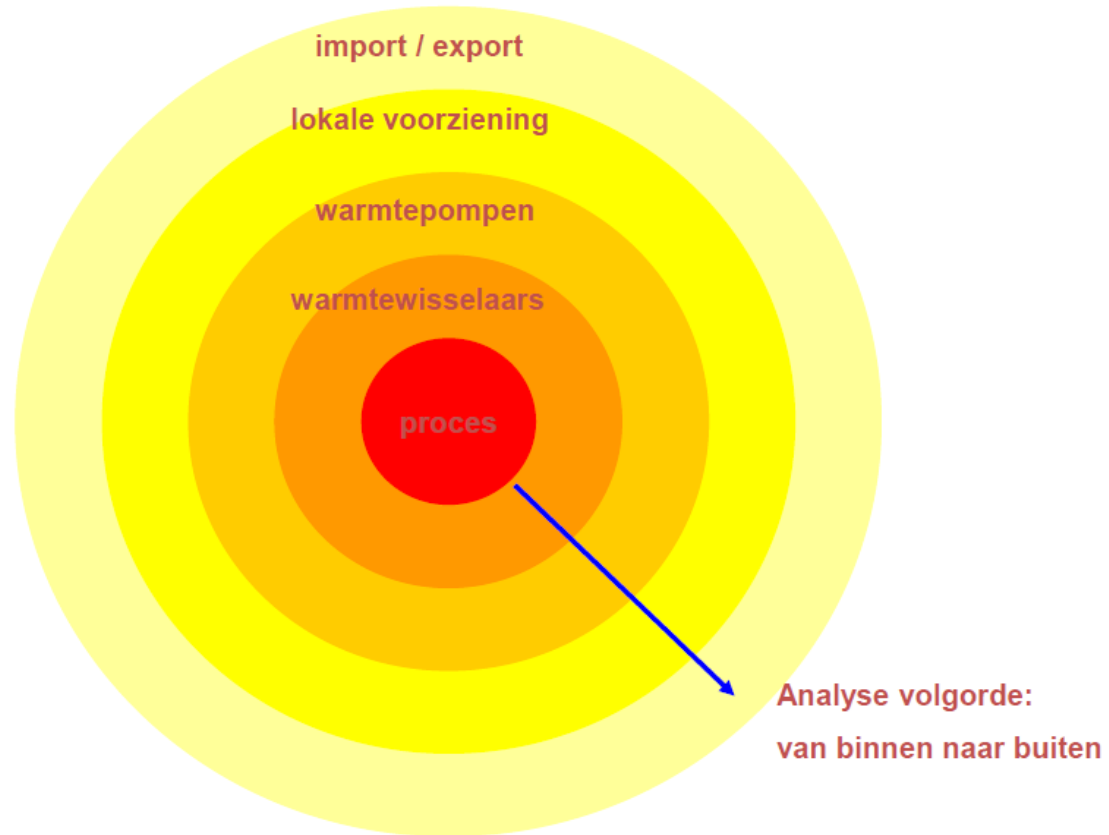

Heat pump example installations

Carbon-neutral smoothie manufacturing site

THE INNOCENT WAY



GEA - CoolingMatters

400 million bottles per year
Zero carbon emission production

Thermal loads:

5,000kw @ -3°C Gycol.

2,970kw @ +7°C chilled water.

5,000kw THR at +32°C.

4,500kw @ +65°C (melt, sanitize, HVAC etc)

2,500kw @ 90°C (process pasteurization etc)

600kg/hr steam at +140°C (Filling)

18

How to make orange juice green

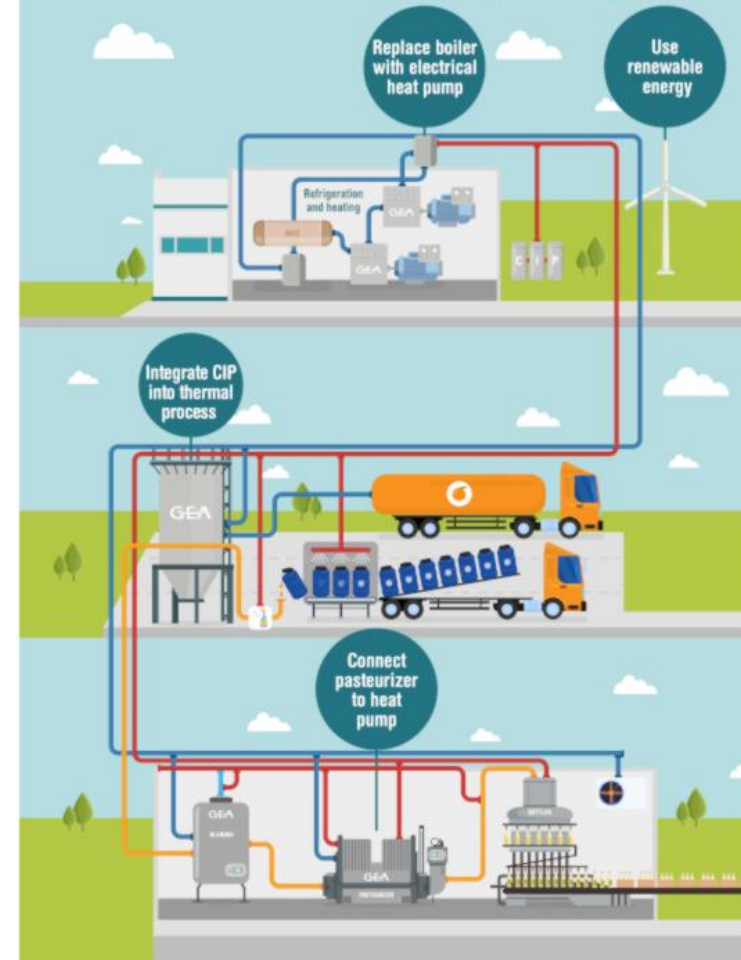

Video: How to make orange juice green

Heat pump example installations

Comparison of OPEX and CO₂ for heating via Ammonia heat pumps vs Steam boiler

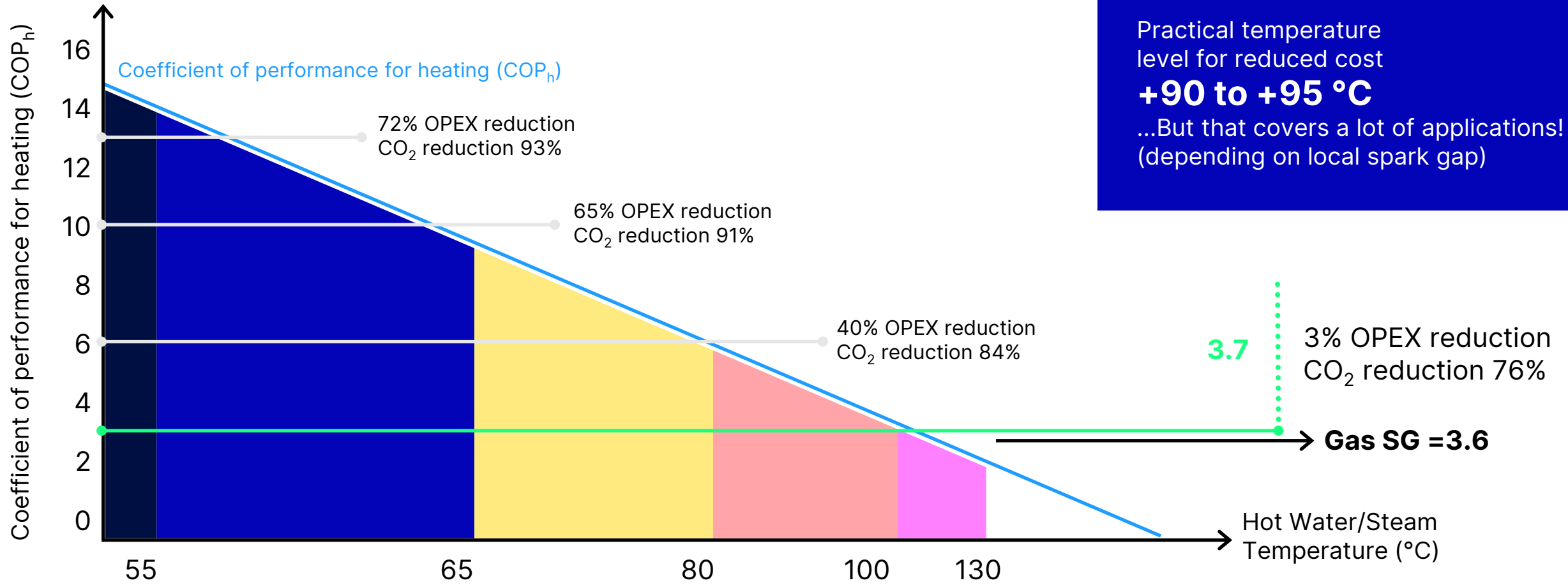

Note: Figures based on Gas = 2p/kWh, Electricity = 10p/kWh, Boiler efficiency = 80%, Spark Gap = 3.6

V XHP project scope

- Ammonia compressor for heat pumps
- Heat sink temperature up to 95°C
- Compressor design pressure 63 bar(g)
- 4 compressor models, 375 to 940 m³/h at 1500 rpm
- Heating capacity at evaporation / condensation 35°C/ 93°C:
950 to 2350 kW

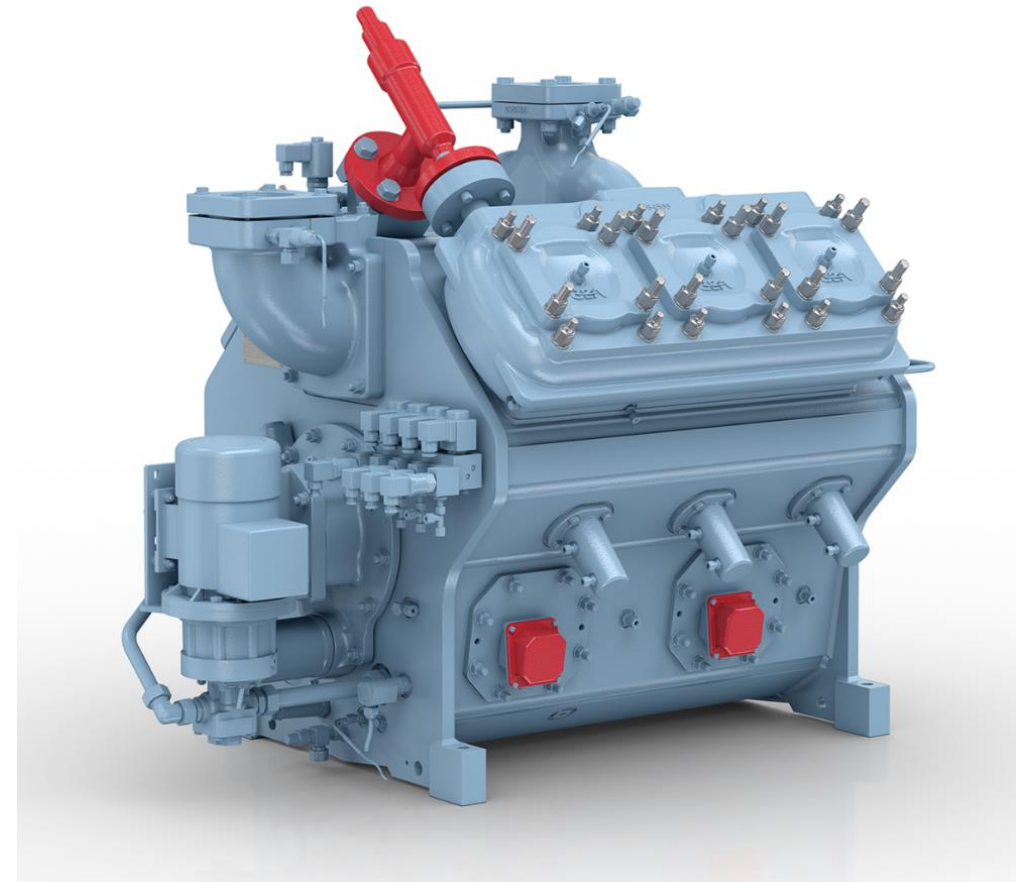

V XHP valves

- State-of-the-art materials
- 1D, 2D and 3D simulations

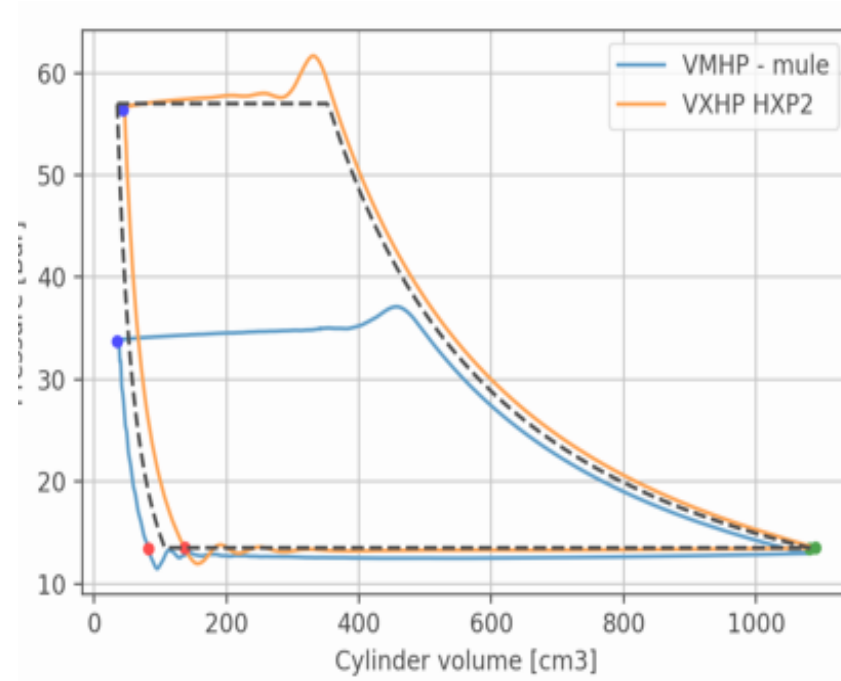
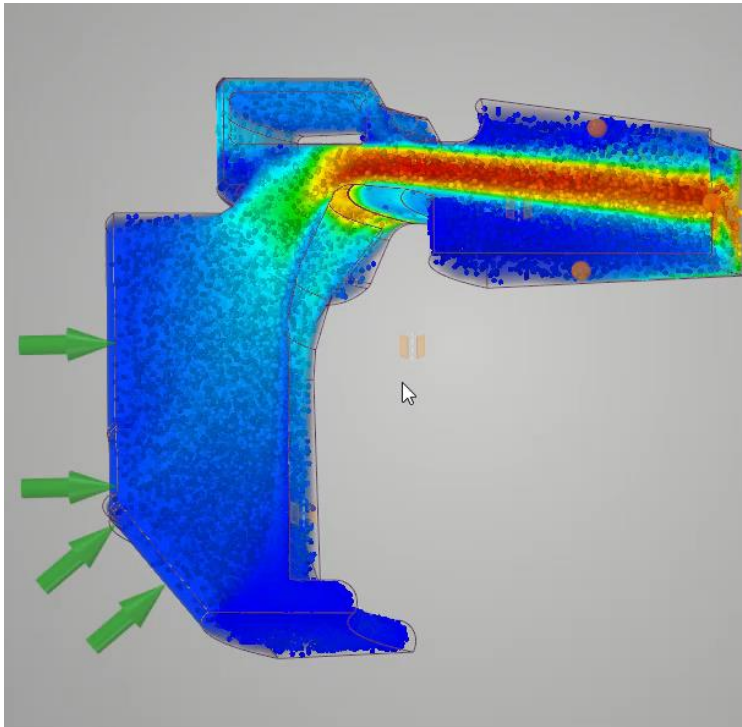

V950 XHP, 10 cylinder model

Test center in Berlin



V550 XHP

Efficiency results

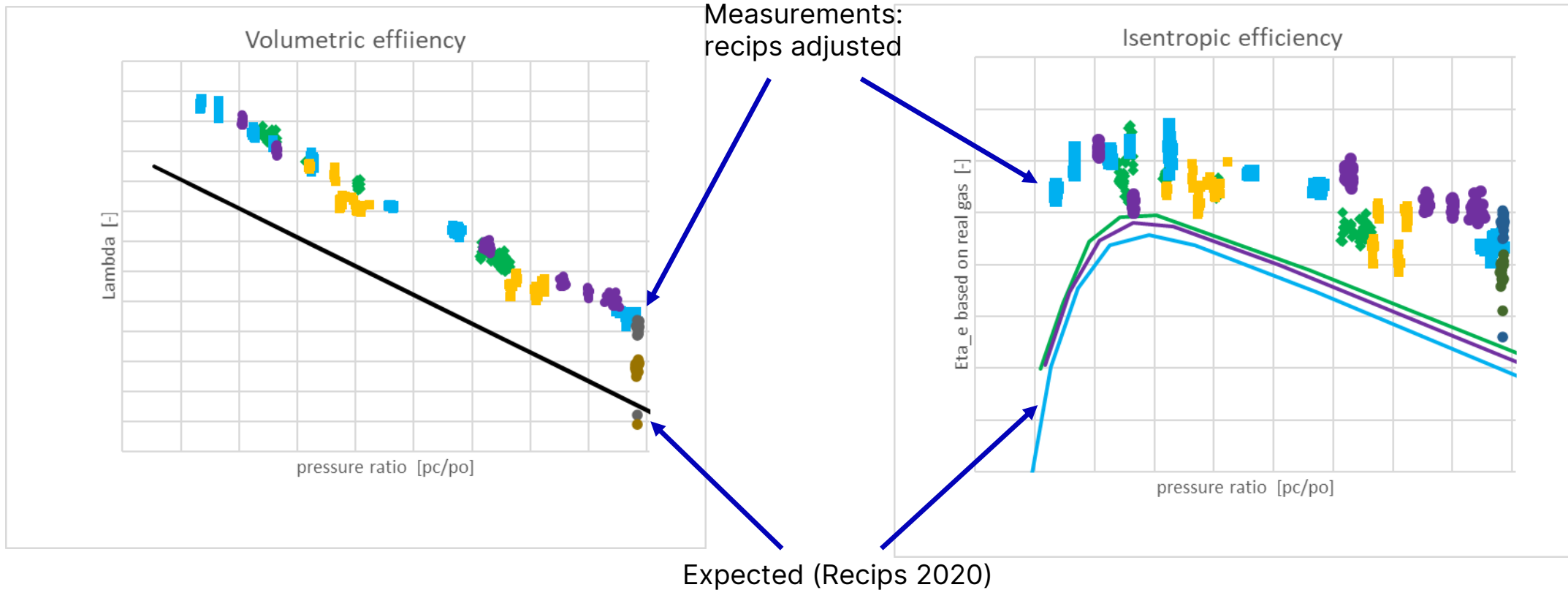



INSTITUT INTERNATIONAL DU FROID
INTERNATIONAL INSTITUTE OF REFRIGERATION

Relationship of the *Transcritical and Subcritical* performance of an *air cooled CO₂-gas cooler*



Geert Doornbos* | Post-HBO Koudetechniek (NL)
Kees van Heiningen | Post-HBO Koudetechniek (NL)
Jan Gerritsen | GEA (NL)



Paper 232

Prestaties CO₂ gaskoeler

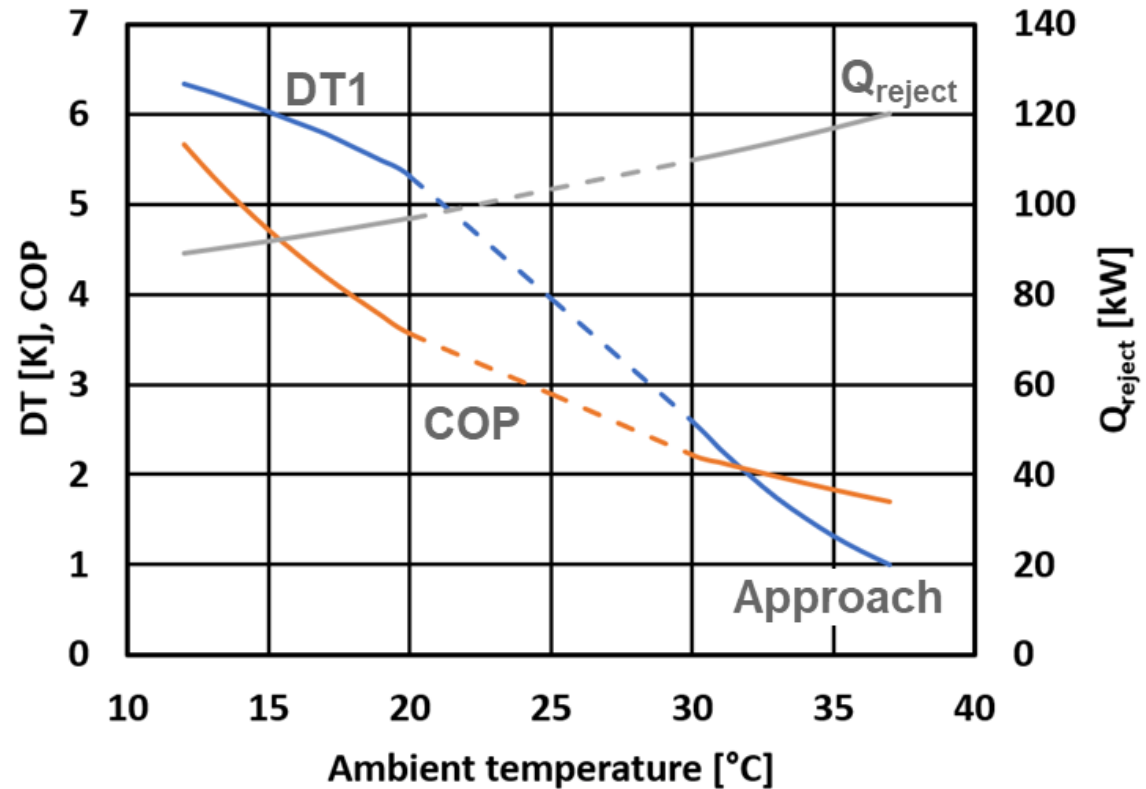

Experimental setup

Gas cooler set-up:

- Closed air supply system
- Air heater to vary ambient conditions
- Air tunnel to measure air flow

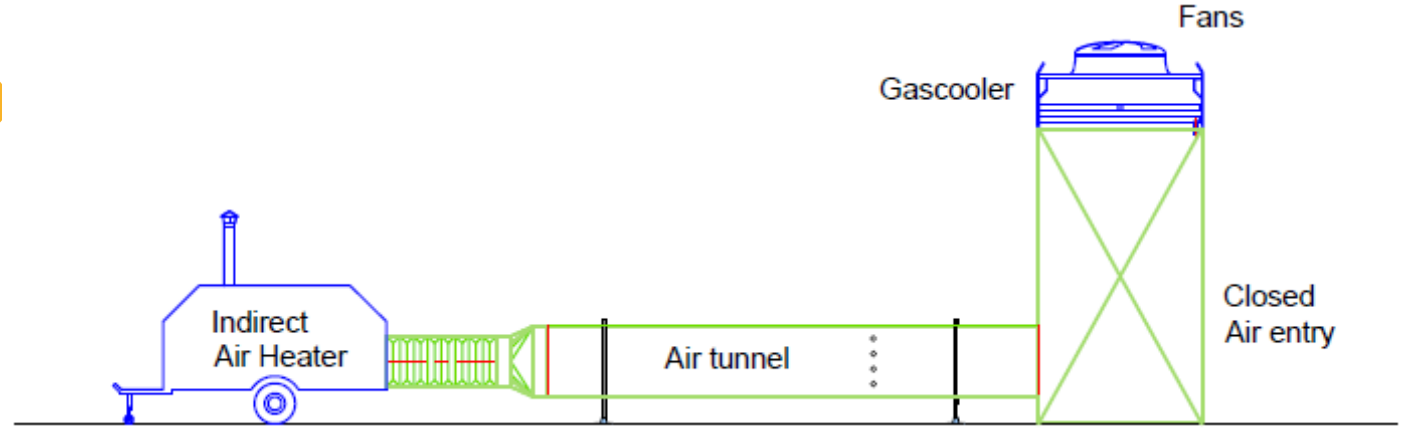

Measurement system:

Datalogging system for T-type sensors with:

- 8 air temperature sensors
- 19 tube temperature sensors (insulated)
- 1 *approach* temperature sensor

Two precision manometers (inlet/outlet GC)

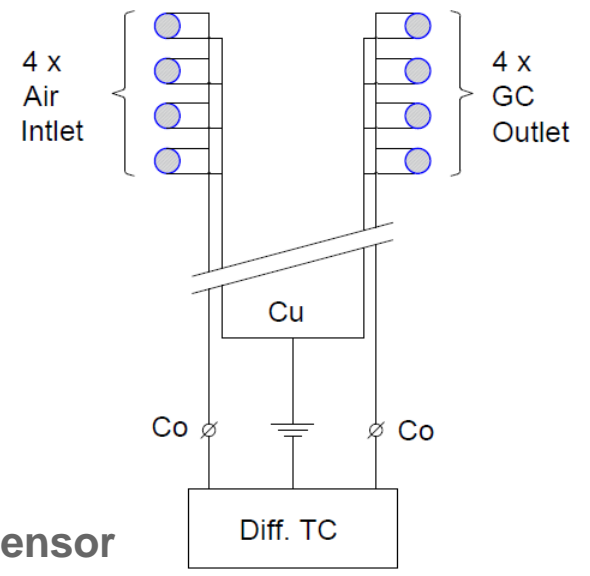

Approach sensor

Transcritisch CO₂ systeem in T-h diagram

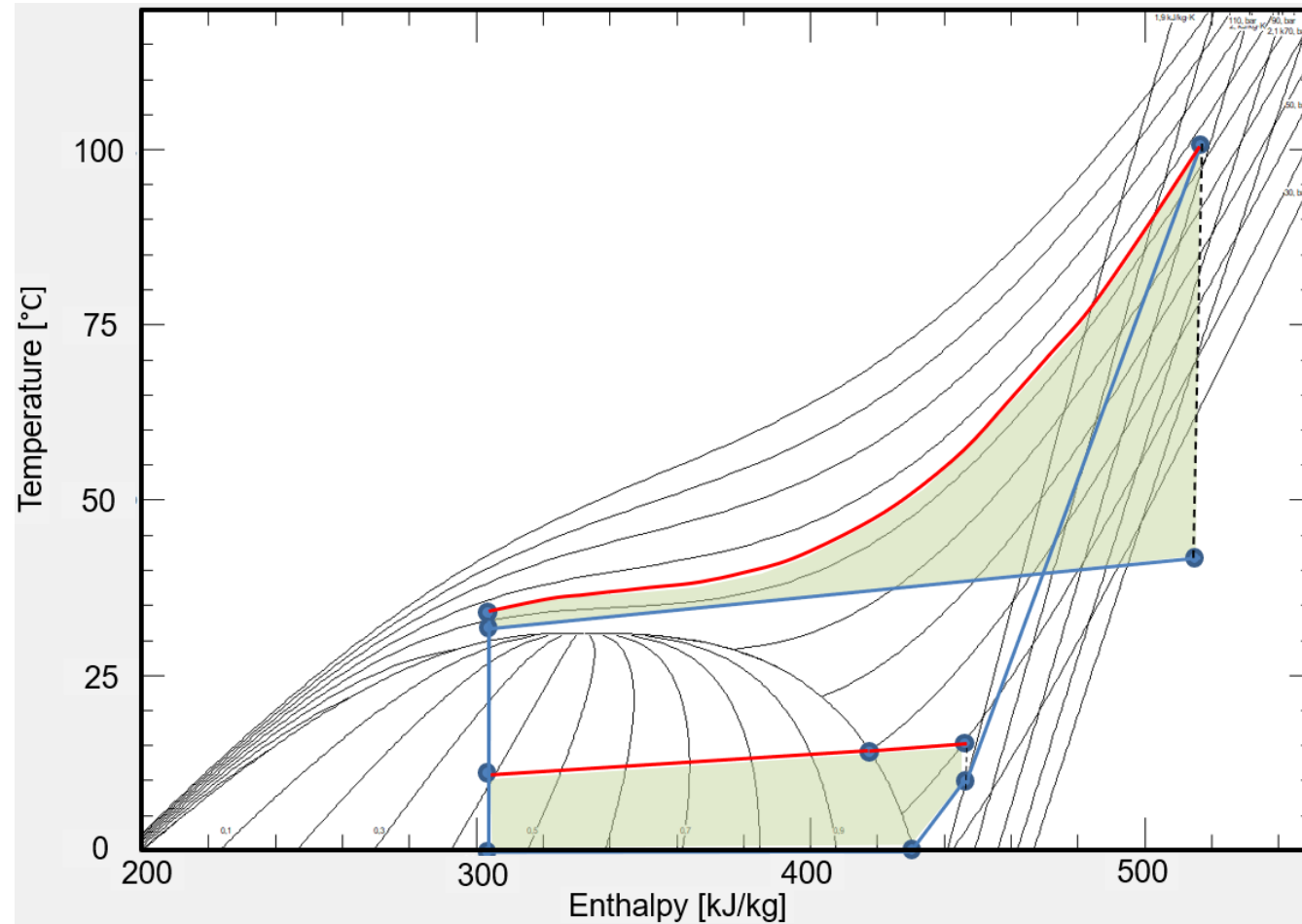

CO2 warmtepomp – 4 gaskoelers in serie

DOI 10.18462/iir.gl.2018.1107

OPTIMUM HIGH PRESSURE FOR TRANSCRITICAL CO₂ HEAT PUMPS
CONSIDERING ISENTROPIC EFFICIENCY AND GLIDING HEAT
EXTRACTION

Klaus Spindler

Institute of Thermodynamics and Thermal Engineering, University of Stuttgart
Pfaffenwaldring 6, D-70550 Stuttgart, Germany
e-Mail: spindler@itw.uni-stuttgart.de

